

8"

EPC-8-WM-RGBW

Architectural LED Cylinder

Cylinder Series



Application

A complete family of cylinders for downlight, wallwashers, double wallwashers, and corner wallwashers in multiple, mounting options, beam spreads and apertures designed for commercial, civic, museums, corporate, hospitality, academic, retail, medical, and houses of worship.

Features

- Exceptional Optical Quality: Up to 98 CRI, 1x2 Step MacAdam Ellipse.
- Shipped standard with a Solite Beam Smoother lens that removes striations from the light source.
- Available with a multitude of dimming protocols and control offerings.

Nominal Lumens	Delivered Lumens	Wattage
900L	852	12
1200L	1098	16
1500L	1421	20
2000L	1925	27

Based on 4000K, 90+ CRI with semi-specular chrome reflector. Actual wattage may vary +/-5%

Lumens	Tunable White: 900, 1200, 1500, 2000, 3000, 4000 RGB + White: 1100, 2000
CCT & Dynamic Platforms	Tunable White: 50K-27K, 65K-27K RGB + White: LENGN-65K-18K
CRI	90+
Color Quality	2 Step MacAdam Ellipse
Distributions	NSPD (Narrow Spot 15°), SPD (Spot 24°), ND (Narrow 30°), MD (Medium 36°), MWD (Medium Wide 52°), WD (Wide 60°), VWD (Very Wide 70°)
Trim Options	Downlight, Wall Wash, Double Wall Wash, Corner Wall Wash, Wet Location
Reflector Colors	CL (Semi-Specular Chrome), SHZ (Low Iridescent Satin Haze), WT (Wheat), W (White), MB (Black), BZ (Bronze)
Flange Colors	Self-Flanged WH (White), SCH (Semi-Specular Chrome), SHZ (Low Iridescent Satin Haze), BK (Black), BZ (Bronze)
Dimming	Tunable White: DIM10, DMX-512, DMX-RDM, DALI, BLE, LUTH RGB + White: ELDODMX.1
Emergency	Tunable White: EMG-LED-10W, EMG-LED-20W, INTG-EMG-LED-10W, INTG-EMG-LED-20W, EMG-LED-G2-10W-SDT RGB + White: PELI-S-20, PELI-S-100, PELI-S-250, PELI-S-400
Lifetime	L70 at 102,000 Hours
Photometric Tests	In Accordance with IES LM79-08, LM80 and TM-30, TM-21



8"

EPC-8-WM-RGBW

Architectural LED Cylinder

Cylinder Series

PART NUMBER: **EPC-8-WM-TWH-50K-27K-900L-90-NSPD-DIM10-120V**

Series	Technology	Lumen:	CRI	Optics	Driver	Voltage	Emergency	Accessories
EPC-8-WM-TW <i>(Tunable White)</i>	50K-27K 65K-27K	900L 1200L 1500L 2000L 3000L 4000L	90+	NSPD <small>Narrow Spot (15°)</small> SPD <small>Spot (24°)</small> ND <small>Narrow (30°)</small> MD <small>Medium (36°)</small> MWD <small>Medium Wide (52°)</small> WD <small>Wide (60°)</small> VWD <small>Very Wide (70°)</small>	DIM10 DMX-512 DMX-RDA DALI BLE LUTH	120V 277V MVOLT ¹	- EMG-LED-10W EMG-LED-20W INTG-EMG-LED-10W INTG-EMG-LED-20W EMG-LED-G2-10W-S	- EC-WC-TWH-HW-MVOLT <small>Dual-channel touch screen wall controller with tunable white technology, supporting 0-10V dimming.</small>

¹ For DIM10 driver you must dedicate two control inputs, one for the Dimming Control and another for CCT Tuning ² Lutron is the T-Series 2-Channel Tunable White EcoSystem

PART NUMBER: **EPC-8-WM-RGBW-LENGN-65K-18K-1100L-90-NSPD-ELDODMX.1-120V**

Series	Technology	Lumens	CRI	Optics	Driver	Voltage	Emergency
EPC-8-WM-RGBW <i>(RGB + White)</i>	LENGN-65K-18K	1100L 2000L	90+	NSPD <small>Narrow Spot (15°)</small> SPD <small>Spot (24°)</small> ND <small>Narrow (30°)</small> MD <small>Medium (36°)</small> MWD <small>Medium Wide (52°)</small> WD <small>Wide (60°)</small> VWD <small>Very Wide (70°)</small>	ELDODMX.1	120V 277V MVOLT	- PELI-S-20 PELI-S-100 PELI-S-250 PELI-S-400

Note: All extra optical accessories, aperture assemblies, and optics can be ordered separately. Check EPL Website for ordering nomenclature.

























8"

Architectural LED Cylinder

EPC-8-WM-RGBW

Cylinder Series

ORDER GUIDE

REFLECTOR TYPE				MOUNTING	COLOR					
REFLECTOR TYPE				MOUNTING	COLOR					
Open Downlight EPD-8-801 	Wall Wash EPD-8-807 	Double Wall Wash EPD-8-877 	Corner Wall Wash EPD-8-827 	Flanged 	ANODIZED FLANGED					
					Clear White CL-WH 	Clear Bronze CL-BZ 	Black White BK-WH 	Satin Haze SHZ-SHZ 	Wheat WT-WT 	
					Clear Semi-Spec CL-SCH 	Satin Haze White SHZ-WH 	Black BK-BK 	Satin Haze Black SHZ-BK 		
					Clear Black CL-BK 	White WH-WH 	Bronze BZ-BZ 	Wheat White WT-WH 		
Open Downlight EPD-8-TL-801 	Wall Wash EPD-8-TL-807 			Trimless 	ANODIZED TRIMLESS					
					White WH 	Black BK 	Clear CL 	Satin Haze SHZ 		



8"

Architectural LED Cylinder

EPC-8-WM-RGBW

Cylinder Series

Modifications Available

Consult factory for modification requests; orders may require shop drawing approval.

Downlight

Our signature anodized reflector, spun to a reverse parabola design, achieves a 50° shielding angle and a 40° cut-off, which eliminates inter-reflections, and enhances low aperture brightness

Wall Wash

The optical assembly delivers uniform ceiling-to-floor wallwashing without creating any visible scallops. The optical assembly is specially designed to extend a beam in two directions for a uniform floor-to-ceiling and side-to-side wash of light.

Double Wall Wash

Used in a corridor to wash both walls, providing both horizontal and vertical illumination that fully illuminates corridors and hallways.

Corner Wall Wash

Replacing the effect that two luminaires provide, a corner wallwasher kicks light across corners that run perpendicular to one another, ultimately providing a 210° wash of light fully covering conjoined walls and surfaces.

Optical Performance and Trim

Spun aluminum anodized single piece reflector. The optical system consists of 1) an upper reflector for a precise beam spread; 2) a solite soft focus lens to diffuse the light source for smooth, striation-free distribution; 3) and a patented lens to control the beam angle and provide a 40° visual cutoff. Available in a variety of beam angles. Integral heatsink comes preinstalled on the housing for maximum heat dissipation and locks together with the reflector to prevent zero light leakage for above the ceiling.

Fully Servicable - Easy Installation & Upgrading

Wall mount bracket provided for direct installation with 3-1/4" to 4" octagonal and square junction box. "

Housing / Mounting

Die-formed constructed cylinder body for maximum heat dissipation and rust protection. Cylinder is available in a variety of post painted colors and custom RAL colors.

Drivers

RGB+White platform with tuning range of 6500K to 1650K, Saturation and Hue Gradients of color can be added in increments of 1% to fully saturated colors at 100% enabling gamut access to pastels and saturated colors (RGBW- 65K-16K). Control via, DMX-512/RDM.

Tunable White Option

Tunable White allows the luminaires to be color tuned via various controls. Create the perfect environment for the desired use of the space or mimic the natural color patterns throughout the day and stimulate circadian rhythm. Available in tuning range of 50K-27K (TWH-50K-27K), 65K-27K (TWH-65K-27K), 65K-18K (TWH-LENGN-65K-18K).

RGB + White Option

Refine your space with Mood Master (RGBW & TW), which provides complete control over hue, color temperature, saturation, and dimming for design versatility. RGB + White technology has a white color tuning range from 6500K to 1650K. RGB color range derived from the primary colors red, green and blue is used to create infinite color options in the RGB palette, adding colors together in varying amounts to create new ones. RGB Tunable White technology enables users to adjust the color temperature, adding gradients of saturated colors. No longer restricted to white light LEDs, lighting designers and architects can manipulate a space with desired hues and shades, altering the color temperature of the room, creating the perfect environment. The use of RGB Tunable White technology in allows infinite possibilities for any application

Dimming & Driver Information

DIM10 - 0-10V dimming on either MVOLT 120, 277 or 347V. Dimmable down to 1% of initial lumens, standard

DMX-512 - EldoLED PowerDrive dimming down to 0.1%. Please see EldoLED website for wiring diagrams and a list of compatible DMX and DALI control systems.

DMX-RDM - EldoLED PowerDrive dimming down to 0.1%. Please see EldoLED website for wiring diagrams and a list of compatible DMX and DALI control systems.

DALI - EldoLED SoloDrive DALI-2. Dimming down to 0.1%

BLE - Bluetooth Casambi enabled controllable

LUTH - Lutron LDE1 Hi-Lume Eco System with Soft Fade to Black 1% dimming

ELDODMX.1 - EldoLED PowerDrive dimming down to 0.1%. Please see EldoLED website for wiring diagrams and a list of compatible DMX and DALI control systems.



8"

EPC-8-WM-RGBW

Architectural LED Cylinder

Cylinder Series

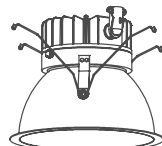
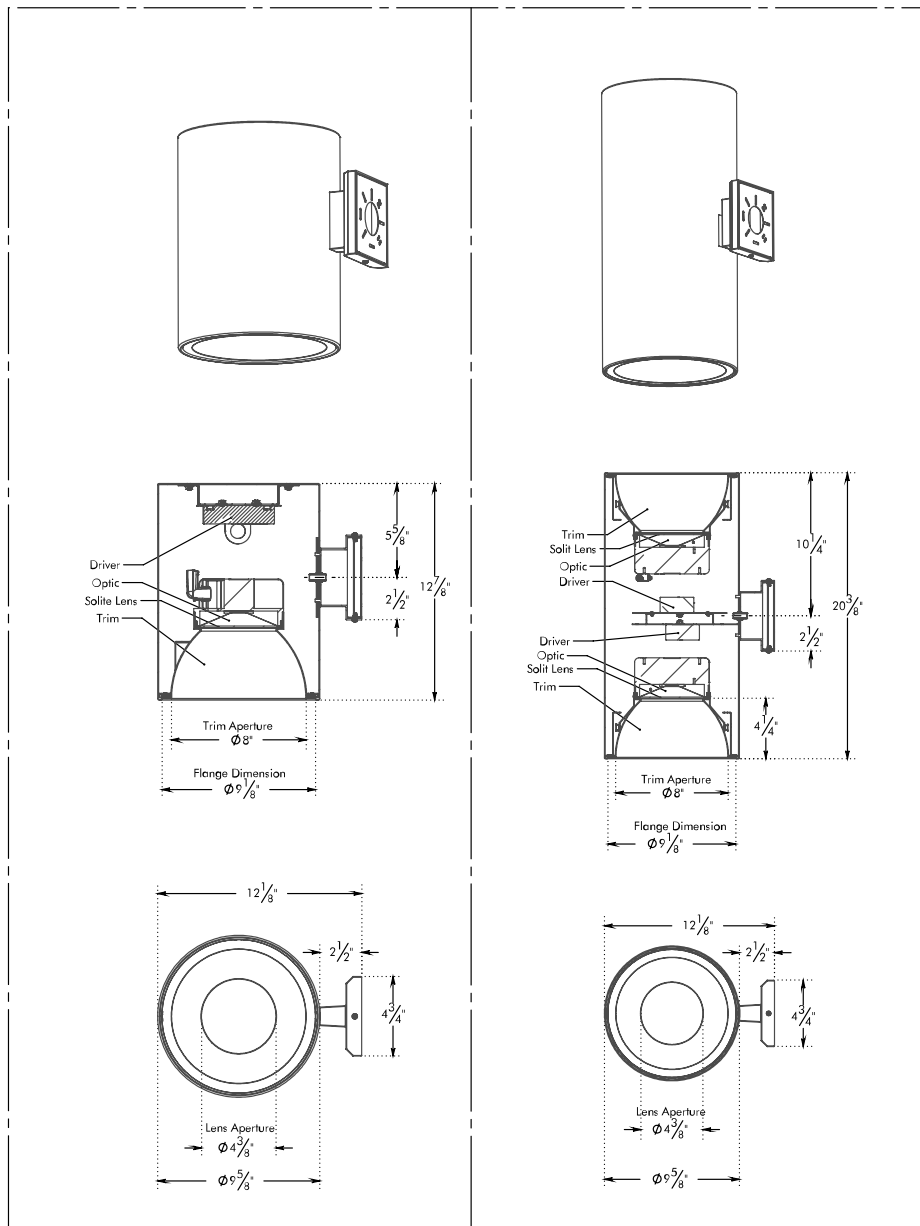

HH8-8501

